

2-Sided Rolling Clear Acrylic Poster Stand, 67"h with 5-Pocket

ASSEMBLY INSTRUCTIONS

Product No. FFM0381P5

Parts & Hardware

Prior to assembly, please be sure all of the parts and hardware are present.
If you are missing any hardware, please call immediately.

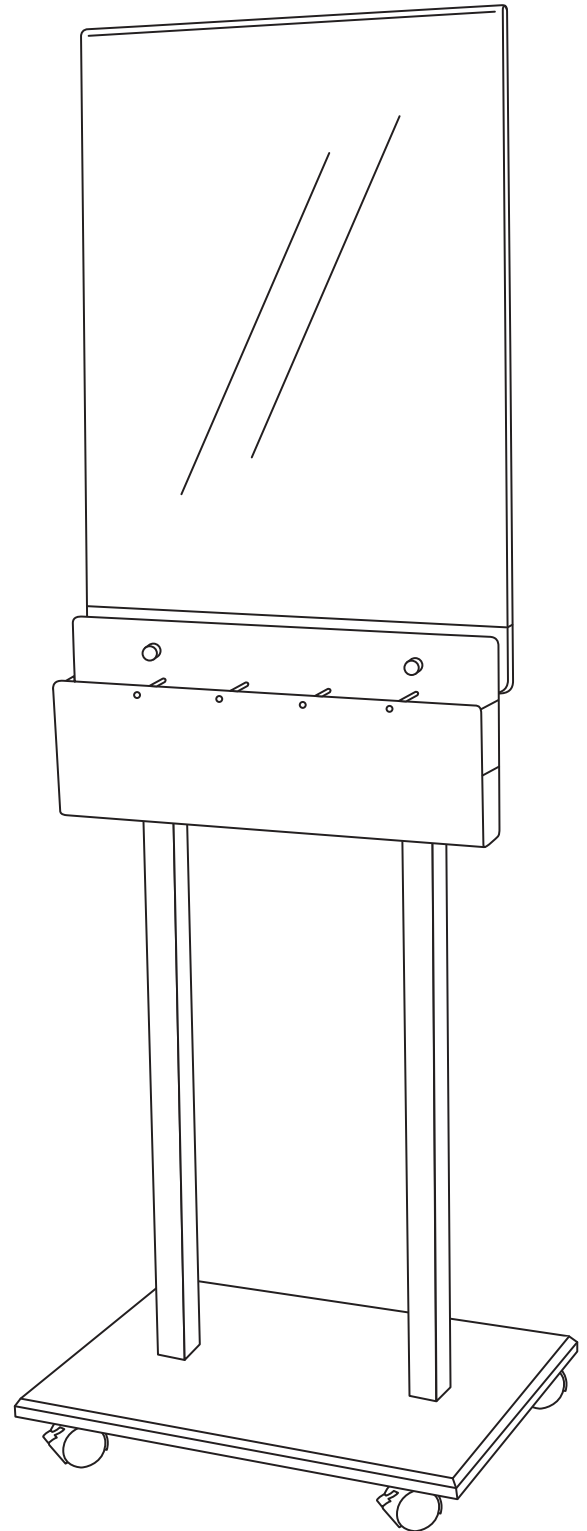
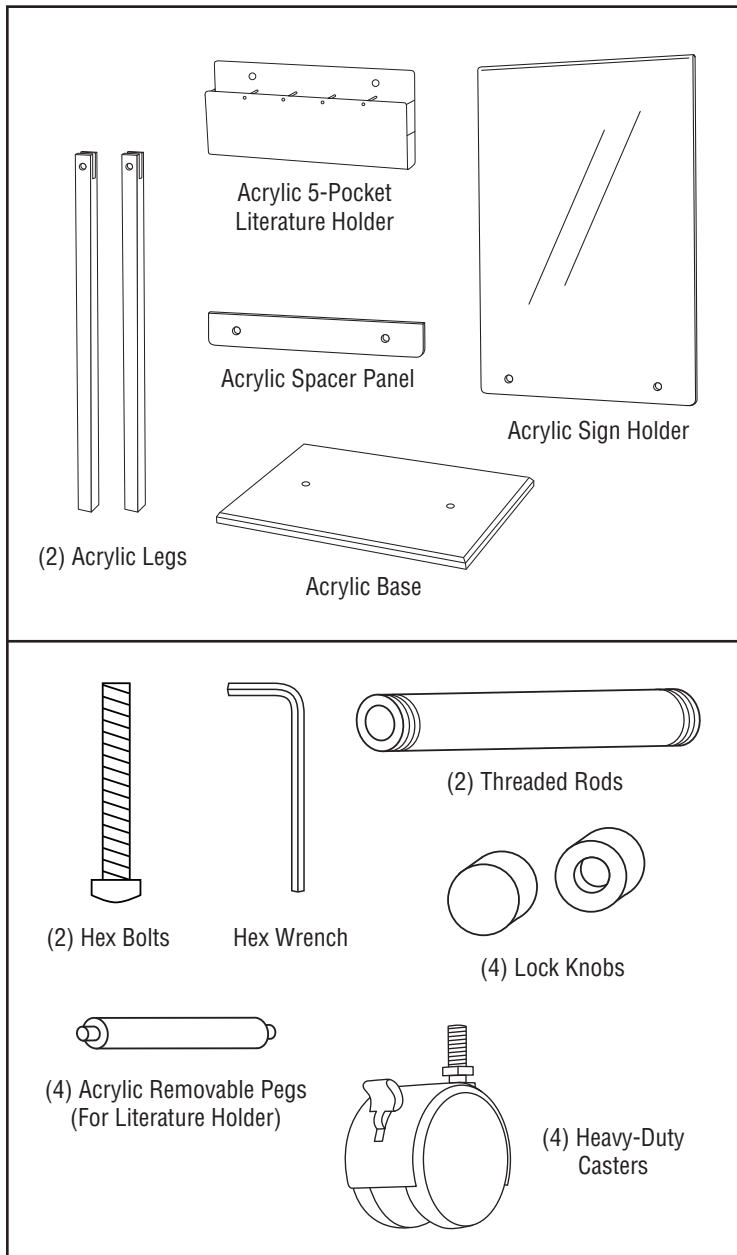

9/16" wrench is NOT included but will be needed for step 1.

2-Sided Rolling Clear Acrylic Poster Stand, 67"h with 5-Pocket

ASSEMBLY INSTRUCTIONS

Product No. FFM0381P5

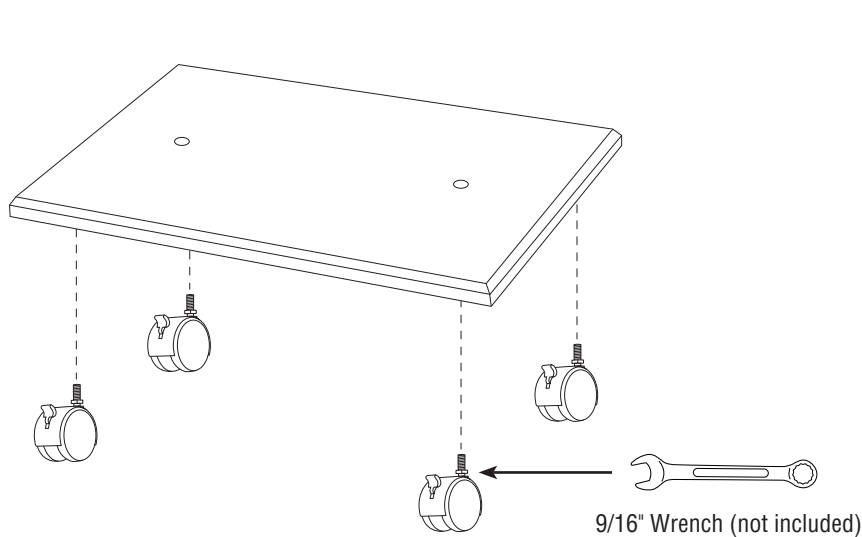

Step 1:

Attach the four heavy-duty casters to the under side of the clear acrylic base. Hand twist the caster bolt into the threaded hole and finish tightening the with a 9/16" wrench (not included) until snug.

Be sure NOT to over tighten the bolt. Over tightening may lead to stripping out the threaded hole and the caster will not fit properly.

Step 2:

Attach the acrylic legs to base unit using the supplied hex bolts & hex wrench - Position each leg keeping them square to the base. Hold each leg in place while tightening the bolt(s) with the hex wrench.

DO NOT Twist the legs to tighten! Twisting the legs to tighten may scratch the surface of the base unit.

* Be sure to keep the legs aligned so the slots are running in the same direction to accept the sign holder & spacer panel.

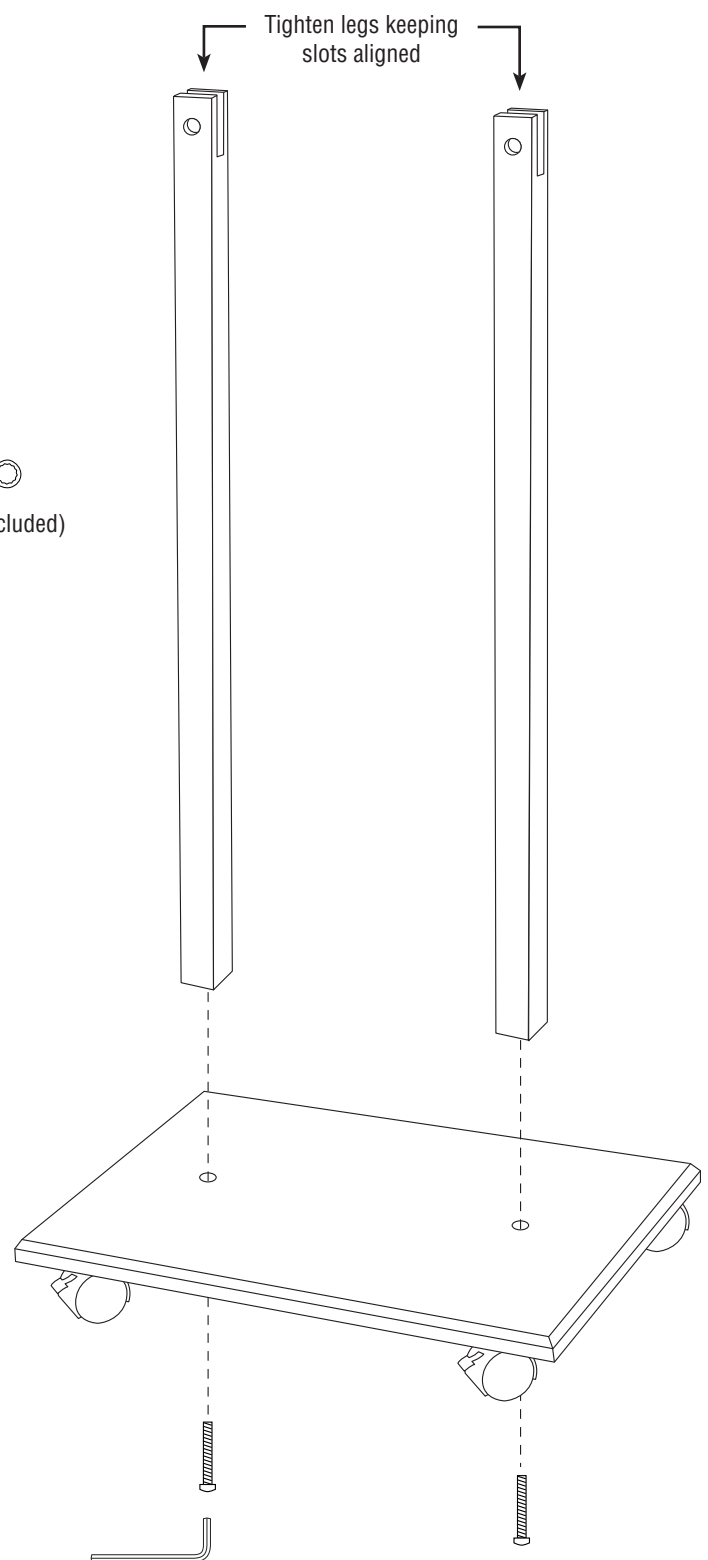

2-Sided Rolling Clear Acrylic Poster Stand, 67"h with 5-Pocket

ASSEMBLY INSTRUCTIONS

Product No. FFM0381P5

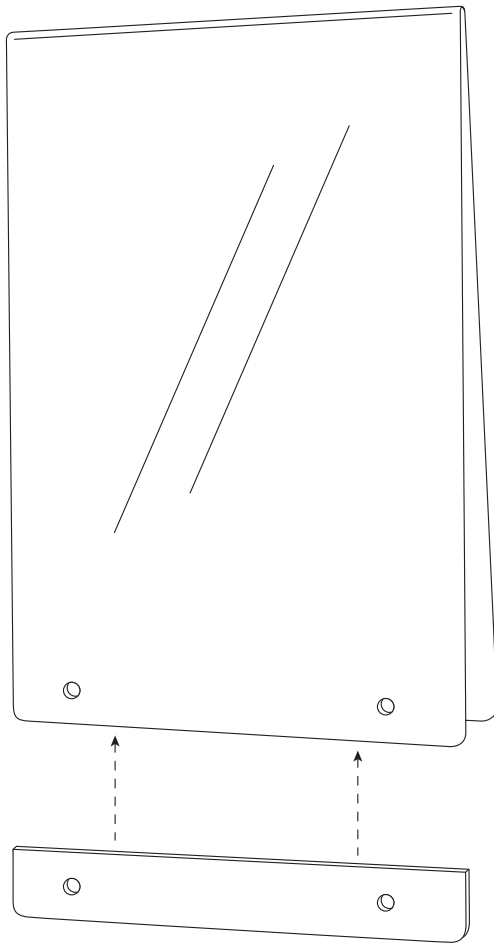

Step 3:

After removing the poster holder & spacer panel from its packaging, peel off the protective film and insert the spacer panel between the two sides of the sign holder keeping the curved corners to the bottom and roughly aligning the holes.

* This is a convenient time to insert your poster(s) and is recommended but not necessary.

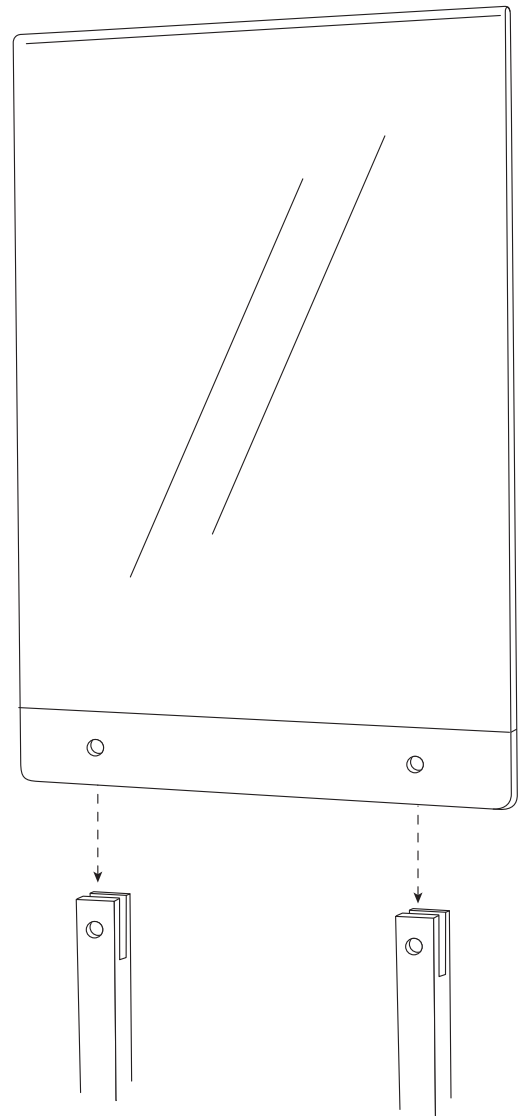

Step 4:

Insert the assembled poster holder & spacer panel into the top slot of the legs roughly aligning the holes.

2-Sided Rolling Clear Acrylic Poster Stand, 67"h with 5-Pocket

ASSEMBLY INSTRUCTIONS

Product No. FFM0381P5

Step 5:

Align the two holes in the back of the 5-pocket literature holder with the holes in the legs/sign holder. Insert the threaded rods through the holes and tighten the lock knobs over each end. Your display is now assembled!

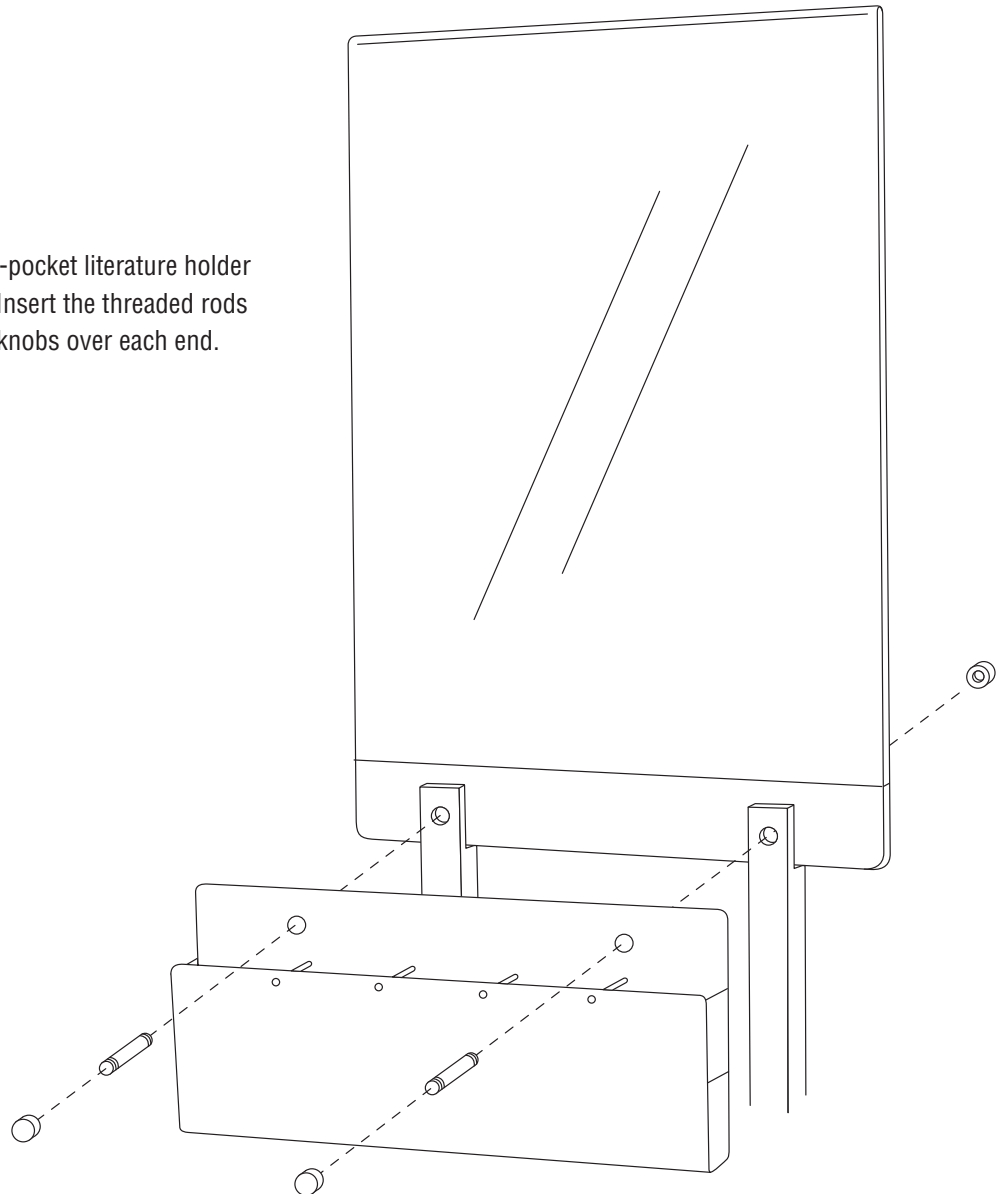

Clean unit with acrylic cleaner (or mild detergent & water) and soft cloth only. **DO NOT USE ALCOHOL!**
For a small container of NOVUS Acrylic Cleaner call today!